

Product description

ESSVE ECM is a styrene-free polyester resin mortar delivered in a 2-component foil tube cartridge system. The product is compatible with a hand-, battery-, or pneumatic tool and a static mixer. It is designed as a cost-effective alternative for the anchoring of threaded rods and internal threaded rod sleeves for approved applications. An easy and safe application in hollow bricks is guaranteed when combined with a perforated sleeve. After full curing application in environments with base material temperature range -40°C to +80°C is possible.

Properties and benefits

- European Technical Assessment for use in masonry: ETA-18/0638
- European Technical Assessment for use in uncracked concrete: ETA-18/0639
- Installation in water-filled bore holes (e.g. rain water)
- Overhead application
- Suitable for attachment points close to the edge, since anchoring is free of expansion forces
- Reduced chemical resistance
- High bending- and pressure strength



Applications samples

Suitable for the fixation of facades, roofs, wood construction, metal construction; metal profile, console, railing, sanitary devices, cable trays, piping, etc.

Handling and storage

Storage: store in a cold and dark place, storage temperature: from +5°C up to +25 °C

Shelf life: Minimum 3 months for foil tubes

Cartridge can be reused up to the end of the shelf life by replacing the static mixer or resealing cartridge with the screw cap

Applications and intended use

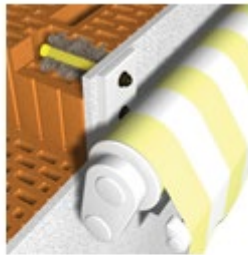

Base material:

Uncracked concrete, light-concrete, porous-concrete, solid masonry, hollow brick, natural stone (Attention! natural stone, can discolour; shall be checked in advance); hammer drilled holes

Anchor elements:

Threaded rods (zinc plated or hot dip, stainless steel and high corrosion resistance steel), reinforcing bars, internal threaded rods, profiled rod, steel section with undercuts (e.g. perforated section)



Temperature range:

Installation temperature 0°C up to +40°C , see curing time below
 Cartridge temperature: +5°C to +40°C
 Base material temperature after full curing: -40°C to +80°C

Mortar properties

Properties	Test Method	Result
UV resistance		Pass
Water tightness	EN 12390-8	0 mm
Temperature stability		120 °C
pH-value		> 12
Density		1,79 kg / dm ³
Compressive strength	EN 196 -1	88 N / mm ²
Flexural strength	EN 196 -1	31 N / mm ²
E-modulus	EN 196 -1	14000 N / mm ²

Curing time

Temperature of base material	Max. working time	Min. curing time
0 °C to +4°C	45 Min.	3 h
+5 °C to +9°C	25 Min.	2 h
+10 °C to +14°C	20 Min.	100 Min.
+15 °C to +19°C	15 Min.	80 Min.
+20 °C to +29°C	6 Min.	45 Min.
+30 °C to +34°C	4 Min.	25 Min.
+35 °C to +39°C	2 Min.	20 Min.
Cartridge temperature	+5°C to +40°C	

Usage instructions – concrete

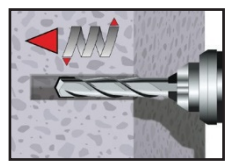
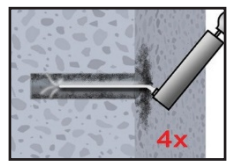
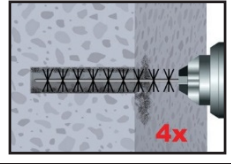
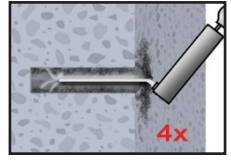
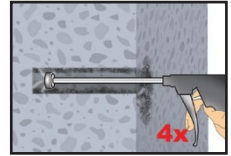
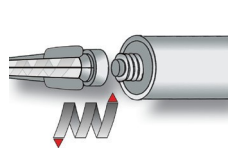
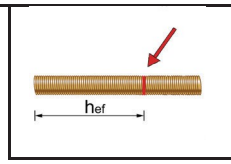
	<p>1. Drill with hammer drill mode a hole into the base material to the size and embedment depth required by the selected anchor (see page 6). In case of aborted drill hole: the drill hole shall be filled with mortar</p>
 <p>4x</p> <p>or</p>	<p>Attention! Standing water must be removed before cleaning.</p> <p>2a. Starting from the bottom or back of the bore hole, blow the hole clean with compressed air (min. 6 bar) or a hand pump (see page 6) a minimum of four times. If the bore hole ground is not reached an extension shall be used. The hand pump can only be used for anchor sizes up to bore hole diameter 20 mm or embedment depth up to 240mm. Compressed air (min. 6 bar) can be used for all sizes.</p>
 <p>4x</p>	<p>2b. Check brush diameter (page 6) and attach the brush to a drilling machine or a battery screwdriver. Brush the hole with an appropriate sized wire brush $> d_{b,min}$ (see page 6) a minimum of four times. If the bore hole ground is not reached with the brush, a brush extension shall be used.</p>
 <p>4x</p> <p>or</p>  <p>4x</p>	<p>2c. Finally blow the hole clean again with compressed air (min. 6 bar) or a hand pump a minimum of four times. If the bore hole ground is not reached an extension shall be used. The hand pump can only be used for anchor sizes up to bore hole diameter 20 mm or embedment depth up to 240mm. Compressed air (min. 6 bar) can be used for all sizes.</p> <p>After cleaning, the bore hole has to be protected against re-contamination in an appropriate way, until dispensing the mortar in the bore hole. If necessary, the cleaning has to be repeated directly before dispensing the mortar. In-flowing water must not contaminate the bore hole again.</p>
	<p>3. Attach a supplied static-mixing nozzle to the cartridge and load the cartridge into the correct dispensing tool. After every working interruption longer than the recommended working time as well as for new cartridges, a new static-mixer shall be used.</p>
 <p>hef</p>	<p>4. Prior to inserting the anchor rod into the filled bore hole, the position of the embedment depth shall be marked on the anchor rods.</p>

Usage instructions – concrete

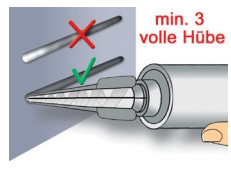
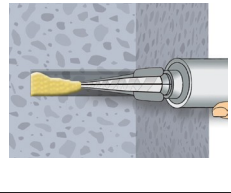
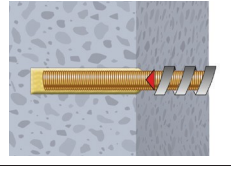
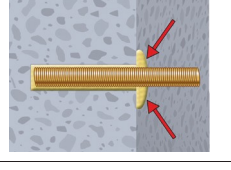
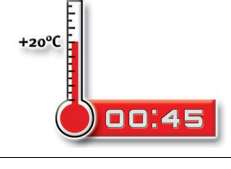
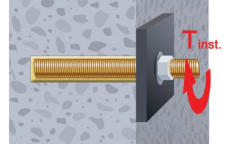
	<p>5. Prior to dispensing into the anchor hole, squeeze out separately a minimum of three full strokes and discard non-uniformly mixed adhesive components until the mortar shows a consistent grey colour.</p>
	<p>6. Starting from the bottom resp. back of the cleaned anchor hole fill the hole up to approximately two-thirds with adhesive. Slowly withdraw of the static mixing nozzle as the hole is filled avoids creating air pockets. For embedments larger than 190mm an extension nozzle shall be used. For overhead and horizontal installation in bore holes bigger than 20mm resp. deeper than 240mm a piston plug shall be used. Observe the gel-/ working times given.</p>
	<p>7. Push the threaded rod or reinforcing bar into the anchor hole while turning slightly to ensure positive distribution of the adhesive until the embedment depth is reached. The anchor should be free of dirt, grease, oil or other foreign material.</p>
	<p>8. Be sure that the anchor is fully seated at the bottom of the hole and that excess mortar is visible at the top of the hole. If these requirements are not maintained, the application has to be renewed.</p>
	<p>9. Allow the adhesive to cure to the specified time prior to applying any load or torque. Do not move or load the anchor until it is fully cured.</p>
	<p>10. After full curing, the add-on part can be installed with the max. torque by using a calibrated torque wrench.</p>

Cleaning of the drill hole – concrete

Threaded rod	Bore hole- \varnothing	Brush- \varnothing	Min. brush- \varnothing
(mm)	(mm)	d_b (mm)	$d_{b,min}$ (mm)
M 8	10,0	12,0	10,5
M 10	12,0	14,0	12,5
M 12	14,0	16,0	14,5
M 16	18,0	20,0	18,5
M 20	24,0	26,0	24,5
M 24	28,0	30,0	28,5

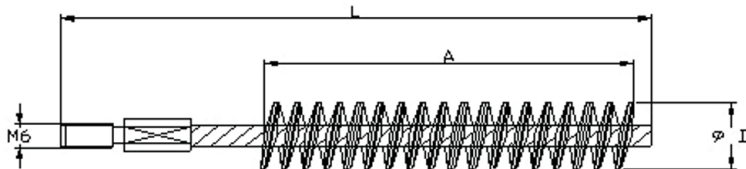

Brush:
 \varnothing 0,20 mm (A2) Steel wire
 Brush length: 80 mm
 M6 thread for drilling machine connection



Blower

Setting parameter

Anchor size (Threaded rod)				M8	M10	M12	M16	M20	M24
Edge distance	$1,0 \times h_{ef}$	$C_{cr,N}$	[mm]	80	90	110	125	170	210
Min. edge distance	$5,0 \times d$	C_{min}	[mm]	40	50	60	80	100	120
Axial distance	$2,0 \times h_{ef}$	$S_{cr,N}$	[mm]	160	180	220	250	340	420
Min. axial distance	$5,0 \times d$	S_{min}	[mm]	40	50	60	80	100	120
Embedment depth		h_{ef}	[mm]	80	90	110	125	170	210
Min. part thickness		h_{min}	[mm]	$h_{ef} + 30$ mm			$h_{ef} + 2d_0$		
Anchor diameter		d	[mm]	8	10	12	16	20	24
Drill diameter		d_0	[mm]	10	12	14	18	24	28
Max. installation torque		$T_{inst.}$	[Nm]	10	20	40	60	120	150

Performance data – concrete

All data is based on Technical Assessment ETA 18/0639 (published 2018-09-24) and applies for:

- Correct installation according to ETA
- No edge distance and spacing influence. It's advised to use our calculation software ESSVE CS for more complicated design situations
- One typical embedment depth, as specified in the table. Including the minimum base material thickness dependant on this embedment depth
- Concrete C 20/25, $f_{ck,cube} = 25 \text{ N/mm}^2$
- Temperature range I (min. base material temp. -40°C , max. long/short term base material temp.: $+24^{\circ}\text{C}/40^{\circ}\text{C}$)
- Steel failure mode is denoted with *underline italics*
- Undersized hot dip galvanized threaded rods (e.g. 5.8U and 8.8U) have a reduced stress area in accordance with ISO 10684 Annex A. This lowers the steel capacity for M8 and M10, larger sizes are not affected
- The Design Resistance includes the partial safety factor for material γ_M and optimal installation safety factor (γ_{inst}), (e.g. dry/wet concrete rather than water-filled hole)
- The Recommended Loads use an overall partial safety factor for action $\gamma = 1.4$, which is an approximation of Eurocode EN 1990

TECHNICAL DATA SHEET

CHEMICAL ANCHOR ECM



Performance data – concrete

ESSVE ECM - Typical embedment depth

		M8	M10	M12	M16	M20	M24
Effective embedment depth, h_{ef}	[mm]	80	90	110	125	170	210
Minimum concrete thickness, h_{min}	[mm]	110	120	140	161	218	266

ESSVE ECM - Characteristic resistance, uncracked concrete, typical embedment depth

			M8	M10	M12	M16	M20	M24
Tension N_{Rk}	[kN]	5.8	17.1	22.6	33.2	50.3	85.5	126.7
		8.8	17.1	22.6	33.2	50.3	85.5	126.7
		A4-70	17.1	22.6	33.2	50.3	85.5	126.7
		HDG 5.8U	17.1	22.6	Same as for 5.8			
		HDG 8.8U	17.1	22.6	Same as for 8.8			

			M8	M10	M12	M16	M20	M24
Shear V_{Rk}	[kN]	5.8	<u>9.0</u>	<u>15.0</u>	<u>21.0</u>	<u>39.0</u>	<u>61.0</u>	<u>88.0</u>
		8.8	<u>15.0</u>	<u>23.0</u>	<u>34.0</u>	<u>63.0</u>	<u>98.0</u>	<u>141.0</u>
		A4-70	<u>13.0</u>	<u>20.0</u>	<u>30.0</u>	<u>55.0</u>	<u>86.0</u>	<u>124.0</u>
		HDG 5.8U	<u>8.0</u>	<u>13.0</u>	Same as for 5.8			
		HDG 8.8U	<u>14.0</u>	<u>22.0</u>	Same as for 8.8			

ESSVE ECM - Design resistance, uncracked concrete, typical embedment depth

			M8	M10	M12	M16	M20	M24
Tension N_{Rd}	[kN]	5.8	9.5	12.6	18.4	27.9	47.5	70.4
		8.8	9.5	12.6	18.4	27.9	47.5	70.4
		A4-70	9.5	12.6	18.4	27.9	47.5	70.4
		HDG 5.8U	9.5	12.6	Same as for 5.8			
		HDG 8.8U	9.5	12.6	Same as for 8.8			

			M8	M10	M12	M16	M20	M24
Shear V_{Rd}	[kN]	5.8	<u>7.2</u>	<u>12.0</u>	<u>16.8</u>	<u>31.2</u>	<u>48.8</u>	<u>70.4</u>
		8.8	<u>12.0</u>	<u>18.4</u>	<u>27.2</u>	<u>50.4</u>	<u>78.4</u>	<u>112.8</u>
		A4-70	<u>8.3</u>	<u>12.8</u>	<u>19.2</u>	<u>35.3</u>	<u>55.1</u>	<u>79.5</u>
		HDG 5.8U	<u>6.4</u>	<u>10.4</u>	Same as for 5.8			
		HDG 8.8U	<u>11.2</u>	<u>17.6</u>	Same as for 8.8			

TECHNICAL DATA SHEET

CHEMICAL ANCHOR ECM



Performance data – concrete

ESSVE ECM - Typical embedment depth

		M8	M10	M12	M16	M20	M24
Effective embedment depth, h_{ef}	[mm]	80	90	110	125	170	210
Minimum concrete thickness, h_{min}	[mm]	110	120	140	161	218	266

ESSVE ECM - Recommended loads, uncracked concrete, typical embedment depth

			M8	M10	M12	M16	M20	M24
Tension N_{rec}	[kg]	5.8	690	915	1340	2030	3455	5125
		8.8	690	915	1340	2030	3455	5125
		A4-70	690	915	1340	2030	3455	5125
		HDG 5.8U	690	915	Same as for 5.8			
		HDG 8.8U	690	915	Same as for 8.8			

			M8	M10	M12	M16	M20	M24
Shear V_{rec}	[kg]	5.8	<u>520</u>	<u>870</u>	<u>1220</u>	<u>2270</u>	<u>3550</u>	<u>5125</u>
		8.8	<u>870</u>	<u>1340</u>	<u>1980</u>	<u>3670</u>	<u>5710</u>	<u>8215</u>
		A4-70	<u>605</u>	<u>930</u>	<u>1400</u>	<u>2565</u>	<u>4015</u>	<u>5785</u>
		HDG 5.8U	<u>465</u>	<u>755</u>	Same as for 5.8			
		HDG 8.8U	<u>815</u>	<u>1280</u>	Same as for 8.8			

Setting data – masonry

ESSVE ECM can also be used for anchorages in masonry, both hollow and solid bricks. For application in hollow bricks perforated sleeves need to be used.

Solid bricks			M8	M10	M12	M16	IG-M6	IG-M8	IG-M10
nominal drill hole diameter	d_o	[mm]	10	12	14	18	10	12	16
embedment depth	h_{ef}	[mm]	80	90	100	100	90	100	100
bore hole depth	h_o	[mm]	80	90	100	100	90	100	100
diameter of clearance hole in fixture	d_f	[mm]	9	12	14	18	7	9	12
diameter of steel brush	$d_b \geq$	[mm]	12	14	16	20	12	14	18







Hollow and solid bricks			M8	M8	M10	M12	M16	IG-M6	IG-M8	IG-M10
perforated sleeve			12x80	16x85 16x130 16x200	16x85 16x130 16x200	20x85 20x130 20x200	20x85 20x130 20x200	16x85 16x130 16x200	20x85 20x130 20x200	20x85 20x130 20x200
nominal drill hole diameter	d_o	[mm]	12	16	16	20	20	16	20	20
embedment depth	h_{ef}	[mm]	80	85 130 200	85 130 200	85 130 200	85 130 200	85 130 200	85 130 200	85 130 200
bore hole depth	h_o	[mm]	85	90 135 205	90 135 205	90 135 205	90 135 205	90 135 205	90 135 205	90 135 205
diameter of clearance hole in fixture	d_f	[mm]	9	9	12	14	18	7	9	12
diameter of steel brush	$d_b \geq$	[mm]	14	18	18	22	22	18	22	22

Performance data – masonry

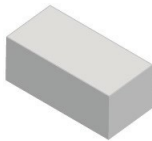

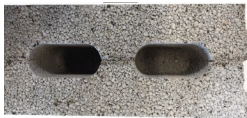

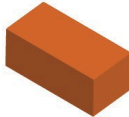
The technical data sheet contains a selection of the most common masonry bricks, more bricks can be found in the masonry ETA.

It is also possible to use the chemical anchor for stones not found in the ETA, but then construction site tests are necessary to obtain a load capacity, the results can be compared with similar bricks from the ETA, contact our technical support for assistance.

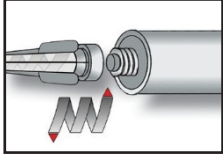
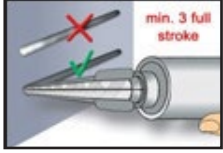
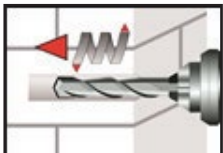

Common bricks from the masonry ETA:

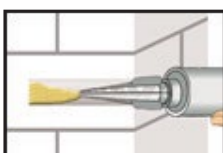
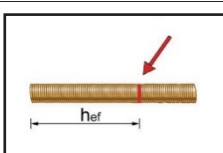
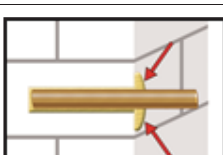
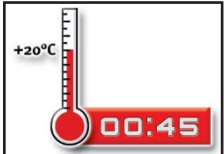
type	figure	dimensions l x b x h [mm]	compressive strength [N/mm ²]	density [kg/dm ³]	producer
solid calcium silica brick KS-NF		≥ 240 x 115 x 71	≥ 10	≥ 2,0	e.g. Wemding (D)
solid light weight con- crete brick LAC		≥ 300 x 123 x 248	≥ 2	≥ 0,6	e.g. Bisotherm (D)
Hollow con- crete brick Leca Lex Hark- ko RUH-200		≥ 498 x 200 x 195	≥ 2,7	≥ 0,7	e.g. Saint Gobain Weber (FIN)
Solid concrete brick Leca Lex Har- kko RUH-200 Kulma		≥ 498 x 200 x 195	≥ 3	≥ 0,78	e.g. Saint Gobain Weber (FIN)
solid clay brick Mz-1DF		≥ 240 x 115 x 55	≥ 10	≥ 1,6	e.g. Unipor (D)
autoclaved ae- rated concrete AAC		≥ 499 x 240 x 249	≥ 2	≥ 0,6	e.g. Porrit (D)

Installation instructions – solid masonry

Preparation of cartridge	
	<p>1. Remove the cap and attach the supplied static-mixing nozzle to the cartridge and load the cartridge into the correct dispensing tool. In case of a foil tube cartridge, cut off the clip before use. For every working interruption longer than the recommended working time (Table B4) as well as for new cartridges, a new static-mixer shall be used.</p>
	<p>2. Initial adhesive is not suitable for fixing the anchor. Prior to dispensing into the anchor hole, squeeze out separately a minimum of three full strokes, for foil tube cartridges six full strokes and discard non-uniformly mixed adhesive components until the mortar shows a consistent grey colour.</p>
Installation in solid masonry (without sleeve)	
	<p>3. Holes to be drilled perpendicular to the surface of the base material by using a hard-metal tipped hammer drill bit. Drill a hole, with drilling method according to Annex C4-C45, into the base material, with nominal drill hole diameter and bore hole depth according to the size and embedment depth required by the selected anchor. In case of aborted drill hole the drill hole shall be filled with mortar.</p>
	<p>4. Blow out from the bottom of the bore hole two times. Attach the brush to a drilling machine or a battery screwdriver, brush the hole clean two times, and finally blow out the hole again two times.</p>
	<p>5. Starting from the bottom or back of the cleaned anchor hole, fill the hole up to min two-thirds with adhesive. Slowly withdraw the static mixing nozzle will avoid creating air pockets. Observe the gel-/ working times given in Table B4.</p>
	<p>6. The position of the embedment depth shall be marked on the threaded rod. Push the threaded rod into the anchor hole while turning slightly to ensure positive distribution of the adhesive until the embedment depth is reached. The anchor shall be free of dirt, grease, oil or other foreign material.</p>
	<p>7. Be sure that the annular gap is fully filled with mortar. If no excess mortar is visible at the top of the hole, the application has to be renewed.</p>
	<p>8. Allow the adhesive to cure to the specified curing time prior to applying any load or torque. Do not move or load the anchor until it is fully cured (attend Table B4).</p>
	<p>9. After full curing, the fixture can be installed with up to the max. installation torque (see parameters of brick Annex C4 to Annex C45) by using a calibrated torque wrench.</p>

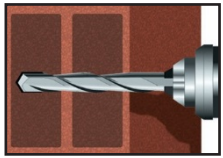
Installation instructions – hollow masonry

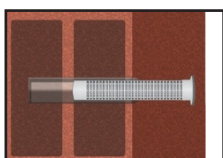
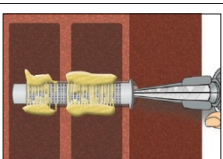
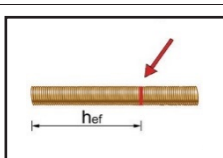
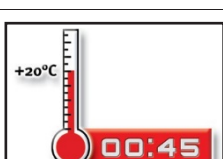
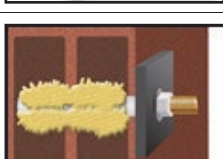
Installation in solid and hollow masonry (with sleeve)	
	<p>3. Holes to be drilled perpendicular to the surface of the base material by using a hard-metal tipped hammer drill bit. Drill a hole, with drill method according to Annex C4 - C45, into the base material, with nominal drill hole diameter and bore hole depth according to the size and embedment depth required by the selected anchor.</p>
	<p>4. Blow out from the bottom of the bore hole two times. Attach the brush to a drilling machine or a battery screwdriver, brush the hole clean two times, and finally blow out the hole again two times.</p>
	<p>5. Insert the perforated sleeve flush with the surface of the masonry or plaster. Only use sleeves that have the right length. Never cut the sleeve.</p>
	<p>6. Starting from the bottom or back fill the sleeve with adhesive. For embedment depth equal to or larger than 130 mm an extension nozzle shall be used. For quantity of mortar attend cartridges label installation instructions. Observe the gel-/ working times given in Table B4.</p>
	<p>7. The position of the embedment depth shall be marked on the threaded rod. Push the threaded rod into the anchor hole while turning slightly to ensure positive distribution of the adhesive until the embedment depth is reached. The anchor shall be free of dirt, grease, oil or other foreign material.</p>
	<p>8. Allow the adhesive to cure to the specified curing time prior to applying any load or torque. Do not move or load the anchor until it is fully cured (attend Table B4).</p>
	<p>9. After full curing, the fixture can be installed with up to the max. installation torque (See parameters of brick Annex C4 to Annex C45) by using a calibrated torque wrench.</p>

Cleaning – masonry



Calculation of recommended loads

The recommended loads are only valid under the following conditions. For a more detailed design see ETA:

- dry environment
- spacing $s \geq s_{cr}$
- edge distance $c \geq c_{cr}$
- masonry mortar of strength class M2,5 to M9
- no prestressing force on the wall
- visible joints
- vertical joints are filled with mortar
- steel strength of anchor rod 5.8 or higher
- the partial safety factors for material and load are already considered
- no interaction of tension and shear loads considered

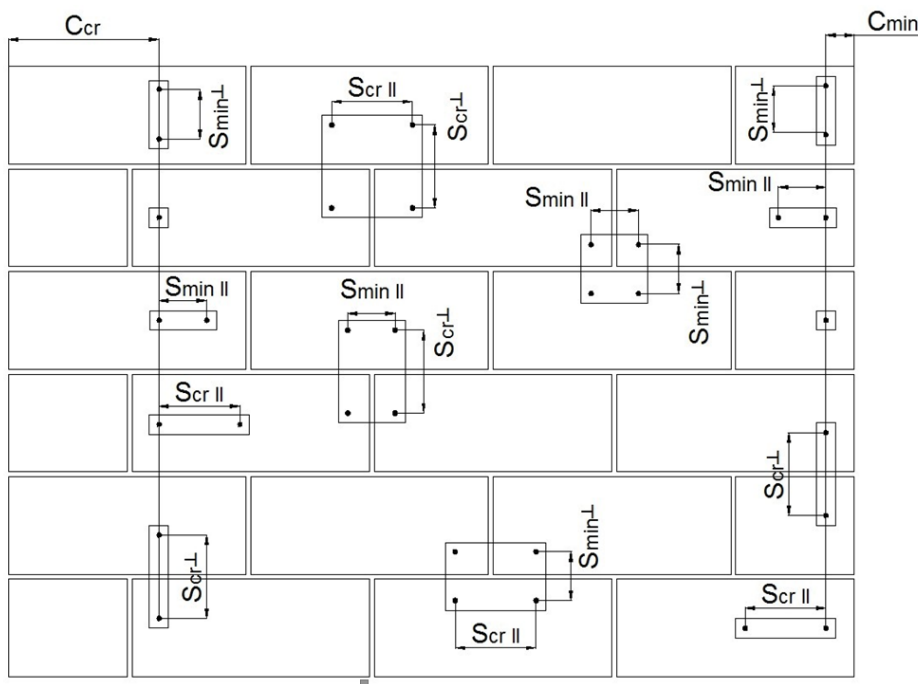

TECHNICAL DATA SHEET

CHEMICAL ANCHOR ECM

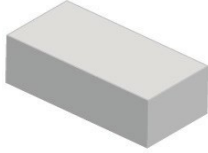

Recommended loads in masonry

solid calcium silica brick KS-NF		dimensions ≥ 240 x 115 x 71	compressive strength ≥ 10 N/mm ²				density ≥ 2,0 kg/dm ³		producer e.g. Wemding (D)	
usage without perforated sleeve			M8	M10	M12	M16	IG-M6 ₃₎	IG-M8 ₃₎	IG-M10 ₃₎	
perforated sleeve			-	-	-	-	-	-	-	
anchorage depth	h_{ef}	mm	80	90	100	100	90	100	100	
minimum wall thickness	h_{min}	mm	115	240	240	240	240	240	240	
installation torque	T_{inst}	Nm	2							
drilling method			hammer drilling							
critical edge distance	c_{cr}	mm	120	135	150	150	135	150	150	
critical axial distance parallel to horizontal joint	$s_{cr, }$	mm	240	270	300	300	270	300	300	
critical axial distance perpendicular to horizontal joint	$s_{cr,T}$	mm	240	270	300	300	270	300	300	
minimal edge distance ²⁾	c_{min}	mm	c_{cr}							
minimal axial distance ²⁾	s_{min}	mm	s_{cr}							
recommended tension load ¹⁾	N_{zul}	kN	0,86							
recommended vertical shear load ¹⁾	$V_{vert.}$	kN	0,86							
recommended horizontal shear load ¹⁾	$V_{hori.}$	kN	0,86							
usage with perforated sleeve			M8	M8	M10	M12	M16	IG-M6 ₃₎	IG-M8 ₃₎	IG-M10 ₃₎
perforated sleeve			12	16	16	20	20	16	20	20
anchorage depth	h_{ef}	mm	80	85; 130; 200						
minimum wall thickness	h_{min}	mm	115	$h_{ef} + 30\text{mm}$						
installation torque	T_{inst}	Nm	2							
drilling method			hammer drilling							
critical edge distance	c_{cr}	mm	120	127,5						
critical axial distance parallel to horizontal joint	$s_{cr, }$	mm	240	255						
critical axial distance perpendicular to horizontal joint	$s_{cr,T}$	mm	240	255						
minimal edge distance ²⁾	c_{min}	mm	c_{cr}							
minimal axial distance ²⁾	s_{min}	mm	s_{cr}							
recommended tension load ¹⁾	N_{zul}	kN	0,71							
recommended vertical shear load ¹⁾	$V_{vert.}$	kN	0,71	0,86						
recommended horizontal shear load ¹⁾	$V_{hori.}$	kN	0,71	0,86						

¹⁾ Conditions and assumptions for the recommended loads, see page 13

²⁾ Reduction factors, see ETA

³⁾ Not covered by the ETA

TECHNICAL DATA SHEET

CHEMICAL ANCHOR ECM

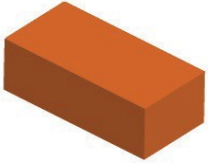

Recommended loads in masonry

solid clay brick Mz-1DF		dimensions ≥ 240 x 115 x 55	compressive strength ≥ 10 N/mm ²				density ≥ 1,6 kg/dm ³			producer e.g. Unipor (D)		
usage without perforated sleeve			M8	M10	M12	M16	IG M6 ³⁾	IG M8 ³⁾	IG M10 ³⁾			
perforated sleeve			-	-	-	-	-	-	-			
anchorage depth	h_{ef}	mm	80	90	100	100	90	100	100			
minimum wall thickness	h_{min}	mm	115	240	240	240	240	240	240			
installation torque	T_{inst}	Nm	2									
drilling method			hammer drilling									
critical edge distance	c_{cr}	mm	120	135	150	150	135	150	150			
critical axial distance parallel to horizontal joint	$s_{cr, }$	mm	240	270	300	300	270	300	300			
critical axial distance perpendicular to horizontal joint	$s_{cr,T}$	mm	240	270	300	300	270	300	300			
minimal edge distance ²⁾	c_{min}	mm	c_{cr}									
minimal axial distance ²⁾	s_{min}	mm	s_{cr}									
recommended tension load ¹⁾	N_{zul}	kN	0,43									
recommended vertical shear load ¹⁾	$V_{vert.}$	kN	0,86	1,0	1,43	1,43	0,86	1,0	1,43			
recommended horizontal shear load ¹⁾	$V_{hori.}$	kN	0,86	1,0	1,43	1,43	0,86	1,0	1,43			
usage with perforated sleeve			M8	M8	M10	M12	M16	IG M6 ³⁾	IG M8 ³⁾	IG M10 ³⁾		
perforated sleeve			12	16	16	20	20	16	20	20		
anchorage depth	h_{ef}	mm	80	85; 130; 200								
minimum wall thickness	h_{min}	mm	115	$h_{ef} + 30mm$								
installation torque	T_{inst}	Nm	2									
drilling method			hammer drilling									
critical edge distance	c_{cr}	mm	120	127,5								
critical axial distance parallel to horizontal joint	$s_{cr, }$	mm	240	255								
critical axial distance perpendicular to horizontal joint	$s_{cr,T}$	mm	240	255								
minimal edge distance ²⁾	c_{min}	mm	c_{cr}									
minimal axial distance ²⁾	s_{min}	mm	s_{cr}									
recommended tension load ¹⁾	N_{zul}	kN	0,57									
recommended vertical shear load ¹⁾	$V_{vert.}$	kN	0,86	0,86	1,0	1,0	1,0	0,86	1,0	1,0		
recommended horizontal shear load ¹⁾	$V_{hori.}$	kN	0,86	0,86	1,0	1,0	1,0	0,86	1,0	1,0		

¹⁾ Conditions and assumptions for the recommended loads, see page 13



²⁾ Reduction factors, see ETA

TECHNICAL DATA SHEET

CHEMICAL ANCHOR ECM



Recommended loads in masonry

solid light weight concrete brick LAC		dimensions ≥ 300 x 123 x 248	compressive strength ≥ 2 N/mm ²	density ≥ 0,6 kg/dm ³	producer e.g. Bisotherm (D)				
usage without perforated sleeve			M8	M10	M12	M16	IG M6 ³⁾	IG M8 ³⁾	IG M10 ³⁾
perforated sleeve			-	-	-	-	-	-	-
anchorage depth		h_{ef} mm	80	90	100	100	90	100	100
minimum wall thickness		h_{min} mm	300						
installation torque		T_{inst} Nm	2						
drilling method			hammer drilling						
critical edge distance		c_{cr} mm	120	135	150	150	135	150	150
critical axial distance parallel to horizontal joint		$s_{cr, }$ mm	240	270	300	300	270	300	300
critical axial distance perpendicular to horizontal joint		$s_{cr,T}$ mm	240	270	300	300	270	300	300
minimal edge distance ²⁾		c_{min} mm	c_{cr}						
minimal axial distance ²⁾		s_{min} mm	s_{cr}						
recommended tension load ¹⁾		N_{zul} kN	0,57						
recommended vertical shear load ¹⁾		$V_{vert.}$ kN	0,86	1,00	1,14	1,14	1,00	1,14	1,14
recommended horizontal shear load ¹⁾		$V_{hori.}$ kN	0,60	0,78	0,98	1,07	0,78	0,98	1,07
solid light weight concrete brick Leca Lex Harkko RUH-200 kulma		dimensions ≥ 498 x 200 x 195	compressive strength ≥ 3 N/mm ²	density ≥ 0,78 kg/dm ³	producer e.g. Saint Gobain Weber (FIN)				
usage without perforated sleeve			M8	M10	M12	M16	IG M6 ³⁾	IG M8 ³⁾	IG M10 ³⁾
perforated sleeve			-	-	-	-	-	-	-
anchorage depth		h_{ef} mm	80	90	100	100	90	100	100
minimum wall thickness		h_{min} mm	300						
installation torque		T_{inst} Nm	2						
drilling method			hammer drilling						
critical edge distance		c_{cr} mm	120	135	150	150	135	150	150
critical axial distance parallel to horizontal joint		$s_{cr, }$ mm	240	270	300	300	270	300	300
critical axial distance perpendicular to horizontal joint		$s_{cr,T}$ mm	240	270	300	300	270	300	300
minimal edge distance ²⁾		c_{min} mm	c_{cr}						
minimal axial distance ²⁾		s_{min} mm	s_{cr}						
recommended tension load ¹⁾		N_{zul} kN	0,57	0,86					
recommended vertical shear load ¹⁾		$V_{vert.}$ kN	0,86	1,14					
recommended horizontal shear load ¹⁾		$V_{hori.}$ kN	0,73	0,95	1,14	1,14	0,95	1,14	1,14



¹⁾ Conditions and assumptions for the recommended loads, see page 13

²⁾ Reduction factors, see ETA

TECHNICAL DATA SHEET

CHEMICAL ANCHOR ECM

Recommended loads in masonry

hollow concrete brick Leca Lex Harkko RUH-200		dimensions ≥ 498 x 200 x 195 mm	compressive strength ≥ 2,7 N/mm ²				density ≥ 0,7 kg/dm ³			producer e.g. Saint Gobain Weber (FIN)
			M8	M8	M10	M12	M16	IG M6 ³⁾	IG M8 ³⁾	IG M10 ³⁾
perforated sleeve			12	16	16	20	20	16	20	20
anchorage depth		h_{ef} mm	80	85; 130						
minimum wall thickness		h_{min} mm	200							
installation torque		T_{inst} Nm	2							
drilling method			rotation drilling							
critical edge distance		c_{cr} mm	100	100	100	120	120	100	120	120
critical axial distance parallel to horizontal joint		$s_{cr,II}$ mm	498							
critical axial distance perpendicular to horizontal joint		$s_{cr,T}$ mm	195							
minimal edge distance ²⁾		c_{min} mm	c_{cr}							
minimal axial distance ²⁾		s_{min} mm	s_{cr}							
recommended tension load ¹⁾		N_{zul} kN	0,57		0,71	0,71	0,57	0,71	0,71	
recommended vertical shear load ¹⁾		$V_{vert.}$ kN	0,71	1,00						
recommended horizontal shear load ¹⁾		$V_{hori.}$ kN	0,26							
autocalved aerated concrete AAC		dimensions ≥ 499 x 249 x 240 mm	compressive strength ≥ 2 N/mm ²				density ≥ 0,2 kg/dm ³			producer e.g. Porit (D)
			M8	M10	M12	M16	IG M6 ³⁾	IG M8 ³⁾	IG M10 ³⁾	
perforated sleeve			-	-	-	-	-	-	-	
anchorage depth		h_{ef} mm	80	90	100	100	90	100	100	
minimum wall thickness		h_{min} mm	240							
installation torque		T_{inst} Nm	2							
drilling method			hammer drilling							
critical edge distance		c_{cr} mm	120	135	150	150	135	150	150	
critical axial distance parallel to horizontal joint		$s_{cr,II}$ mm	240	270	300	300	270	300	300	
critical axial distance perpendicular to horizontal joint		$s_{cr,T}$ mm	240	270	300	300	270	300	300	
minimal edge distance ²⁾		c_{min} mm	75							
minimal axial distance ²⁾		s_{min} mm	100							
recommended tension load ¹⁾		N_{zul} kN	0,89	1,43	1,79	2,32	1,43	1,79	2,32	
recommended vertical shear load ¹⁾		$V_{vert.}$ kN	2,14	3,03	3,57	3,57	1,79	3,21	3,57	
recommended horizontal shear load ¹⁾		$V_{hori.}$ kN	1,29	1,68	2,13	2,32	1,44	1,88	2,01	

¹⁾ Conditions and assumptions for the recommended loads, see page 13

²⁾ Reduction factors, see ETA